

*SPECIFIKATIONER

Lydisolering:

R_w 41 / 44 / 45 dB

Varmeoverførsel:

1,3 / 1,5 W/(m²·K)

Indbrudssikring:

RC2 (Lås ASSA 310)

RC3 (låse ASSA 510 og FIX510 / ASSA

310+Mottura 40705) VAND/LUFT/VIND:

Vandtæthed: **klasse 5A**

Luftgennemtrængelighed: **klasse 3**

Modstand mod vindbelastning: **klasse C4**

"DSA3" DØRSTØRRELSER

MÅL FOR ENKELTFLØJET DØR

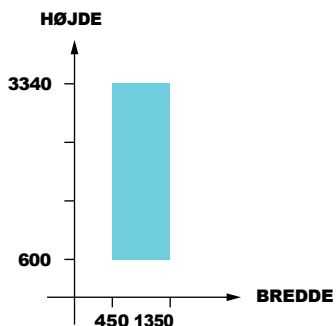

● Maksimale produktionsdimensioner

MÅL FOR DOBBELTFLØJEDE DØRE

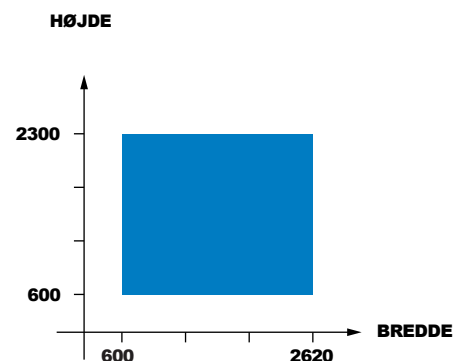

● Maksimale produktionsdimensioner

"DSA3" DØRTVÆRSNIT

ENKELTFLØJET DØR TVÆRSNIT MED C-RAMME

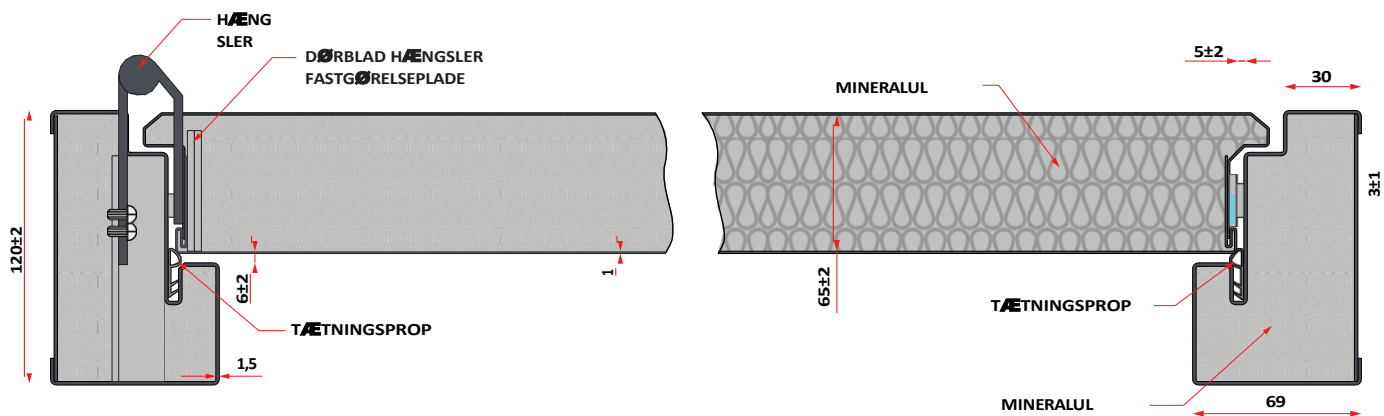

DOBBELTFLØJET DØR MED TVÆRSNIT OG C-RAMME

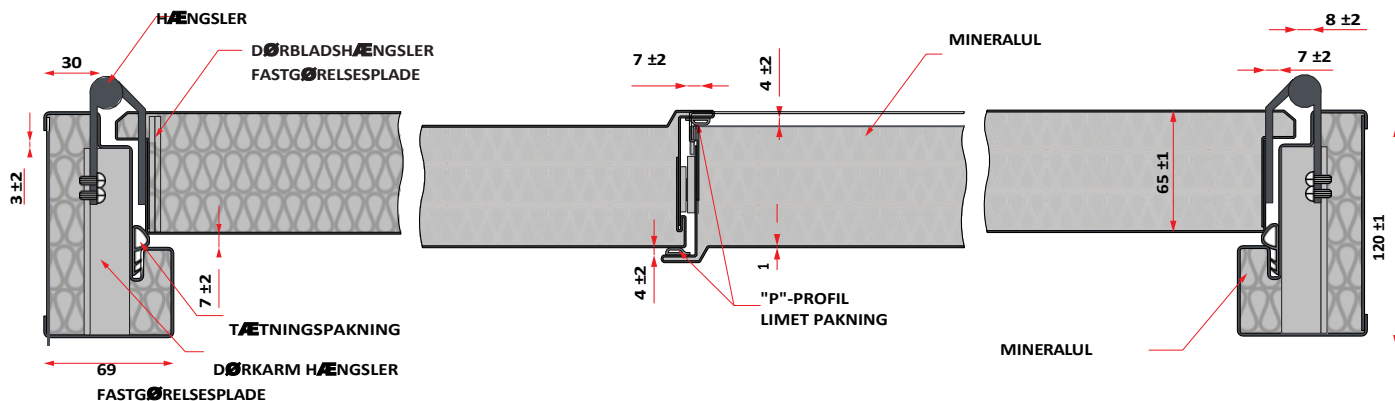

"DSA3" DØRKARMSTYPER

DØRKARM - DSA C

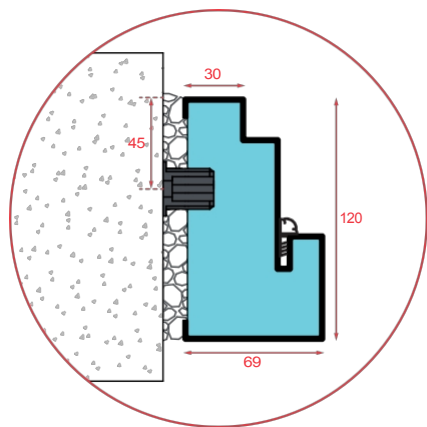

DØRKARM - DSA C15

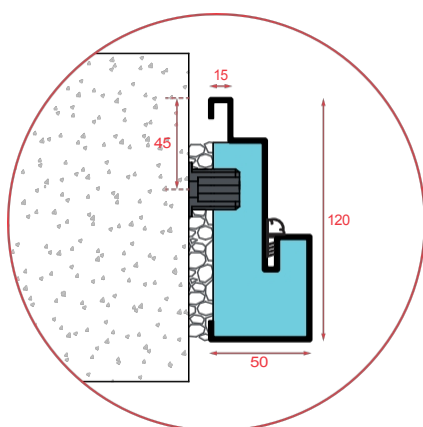

DØRKARM - B

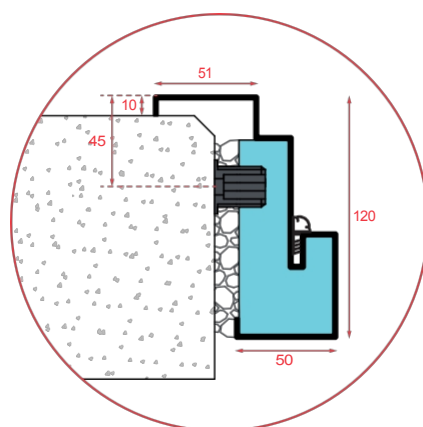

DØRKARM - DSA B IM

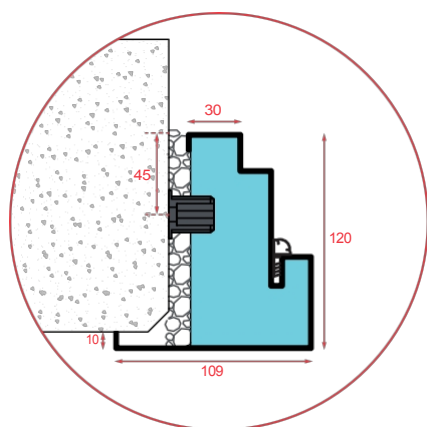

DØRKARM B MED UNDERKARME

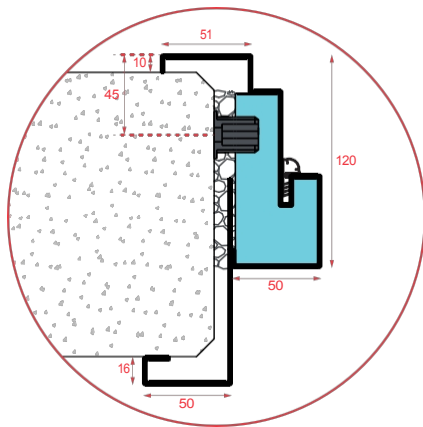

"DSA3"-TÆRSKELVÆRDIER

LN 8/20

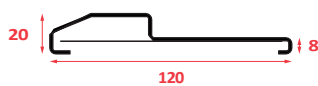

LN 12/25 *

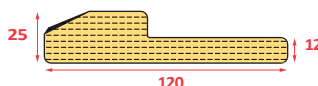

L12/25 *



L20/35 *



L30/45 *

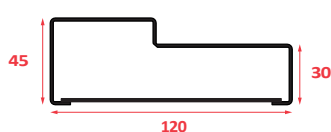

L40/55 *

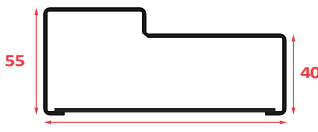

L5/20



I4



Mekanisk tærskel

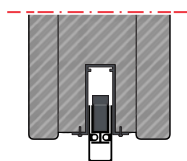

Slaplist

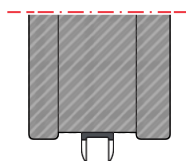

* Denne type tærskel kan være fremstillet af stål eller hårdtræ.